



BRIEFING SESSION

**INVITATION TO REGISTER INTEREST AND SUBMIT A DRAFT UNIVERSAL SERVICE PLAN
AS A UNIVERSAL SERVICE PROVIDER
UNDER THE COMMUNICATIONS AND MULTIMEDIA (UNIVERSAL SERVICE PROVISION)
REGULATIONS 2002**

**FOR PROVISIONING OF FIBRE OPTIC BROADBAND ACCESS NETWORK AND SERVICES
AT THE UNIVERSAL SERVICE TARGETS UNDER THE NATIONAL FIBERISATION AND
CONNECTIVITY PLAN 3 (NFCP 3)**

**INFRASTRUCTURE DIVISION
21 February 2020**

Invitation Ref. No: MCMC/INFD/IDD(01)/NFCP3/TC/02/2020(02)

NFCP WAS LAUNCHED ON 19 SEPTEMBER 2019



“

The NFCP facilitates digital connectivity and enables the Rakyat to enjoy holistic changes through initiatives such as fibre broadband accessibility and construction of communications towers. It is a catalyst to bridge the digital divide between the rural and urban areas, as well as providing equal opportunities for all

”

“

NFCP will chart a new era in Malaysia with a broadband coverage that is *robust, pervasive, high quality and affordable*. It will benefit the local communities, encouraging them to be involved in the digital economy, creating 20,000 job opportunities that involves the construction, operation and maintenance of digital infrastructure and at the same time, stimulate the nation's economic growth

”

Press release dated 19 September 2019: NFCP spurs economic competitiveness, enhanced standard of living for the Rakyat, towards shared prosperity

7 NFCP TARGETS



Why NFCP?

Catalysing Future Economic Growth



Address issues that hinder the widespread availability of high quality and affordable digital connectivity



Support the needs of the country moving forward and harness opportunities offered by new services / technologies



Provide clarity in terms of strategic directions for initiatives to support the digital economy and adoption of future technology

<https://www.nfcp.my>



Entry-level **fixed broadband package** at 1% of GNI by 2020



Gigabits availability in selected industrial areas by 2020 and to all State Capitals by 2023



100% availability for premises in State Capitals and selected high impact areas with a minimum speed of **500Mbps** by 2021



20% availability for premises in sub-urban and rural areas with up to **500Mbps** by 2022



Fibre network passes 70% of schools, hospitals, libraries, police stations and post offices by 2022



Average speeds of 30Mbps in 98% of populated areas by 2023



Improve **mobile coverage** along **Pan Borneo Highway** upon completion

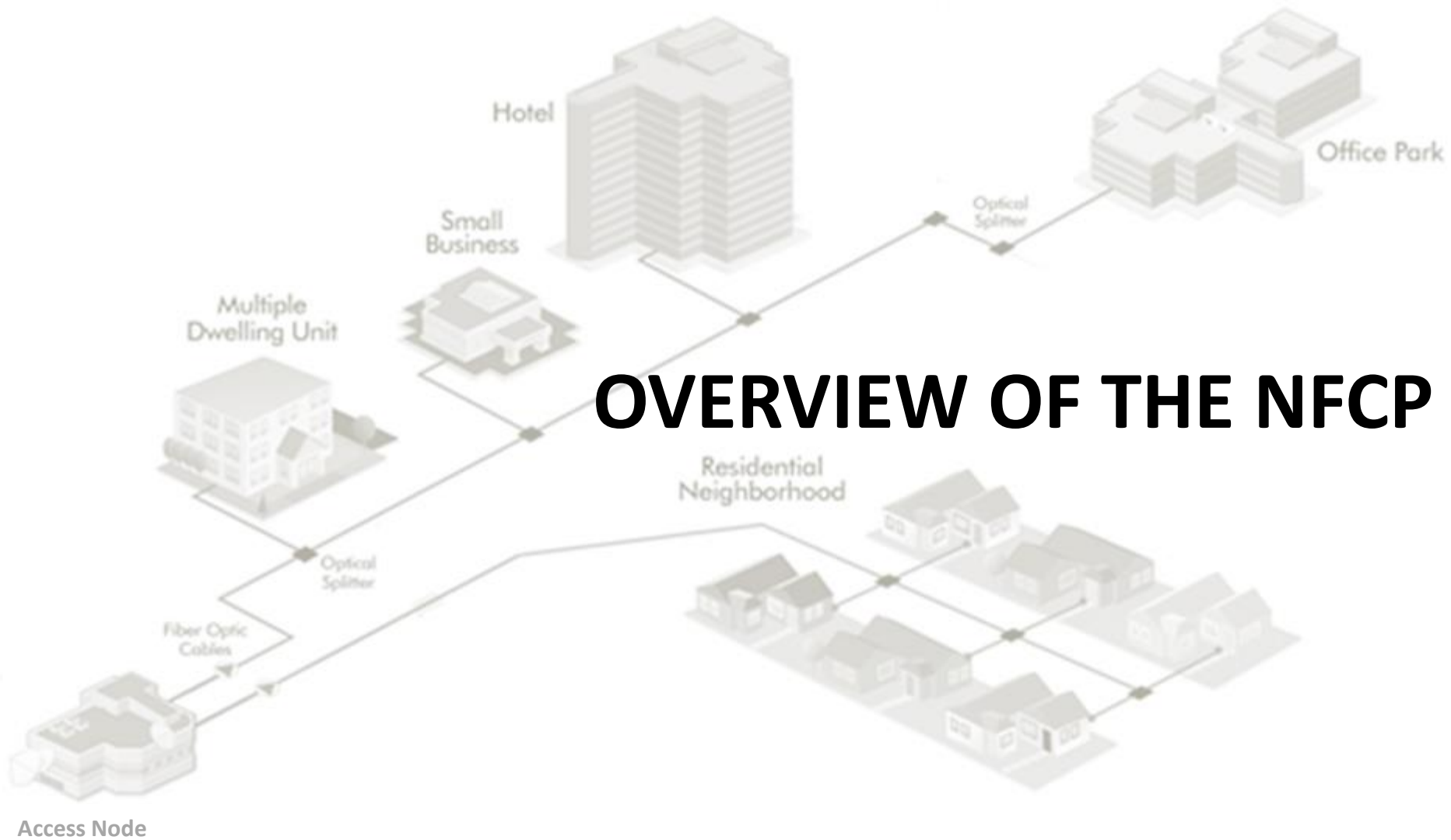

OVERVIEW OF THE NCFP 3 PROJECT

OVERVIEW OF THE NFCP 3 PROJECT

- Commission's efforts to plan and implement universal service provision in Malaysia, in accordance with the objectives as specified in subregulation 3(1) of the USP Regulations 2002.



Provision of fibre optic broadband access network and services at the universal service target areas



Network speeds of at least **500Mbps**

Service with minimum speeds of **30Mbps**

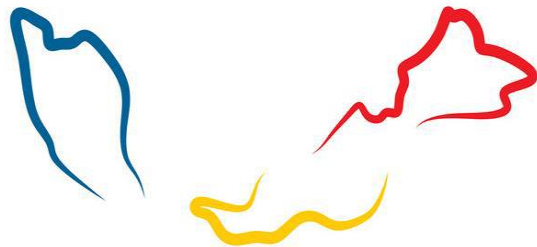

100,000 premises at **74** target locations
(contribution towards NFCP target #4 = 2%)

DISTRIBUTION OF 74 TARGET LOCATIONS UNDER NFCP 3 (1/2)

Cluster	
1	Sabah
2	Sarawak
3	Johor and Negeri Sembilan
4	Selangor
5	Kedah, Perak and Perlis
6	Kelantan, Pahang and Terengganu

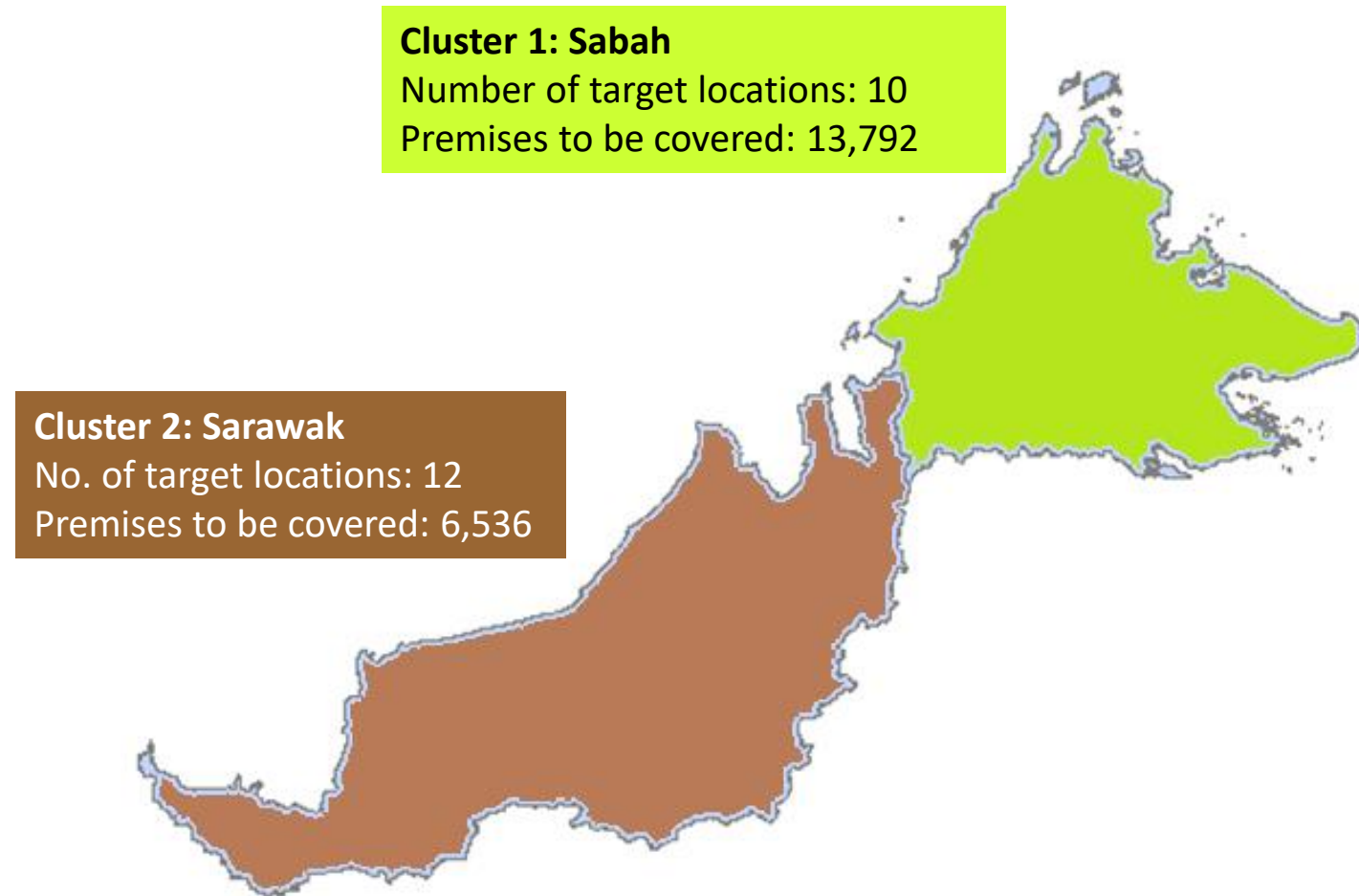

Please refer to Appendix 2, page 27-30 of the RFP

DISTRIBUTION OF 74 TARGET LOCATIONS UNDER NFCP 3 (2/2)

Cluster 5: Kedah, Perak and Perlis

Kedah

No. of target locations: 7
Premises to be covered: 6,328

Perak

No. of target locations: 5
Premises to be covered: 3,536

Perlis

No. of target locations: 1
Premises to be covered: 512

Cluster 6: Kelantan, Terengganu and Pahang

Kelantan

No. of target locations: 10
Premises to be covered: 14,584

Terengganu

No. of target locations: 2
Premises to be covered: 384

Pahang

No. of target locations: 5
Premises to be covered: 6,744

Cluster 4: Selangor

No. of target locations: 12
Premises to be covered: 34,624

Cluster 3: Johor and Negeri Sembilan

Johor

No. of target locations: 7
Premises to be covered: 10,720

Negeri Sembilan

No. of target locations: 3
Premises to be covered: 2,240

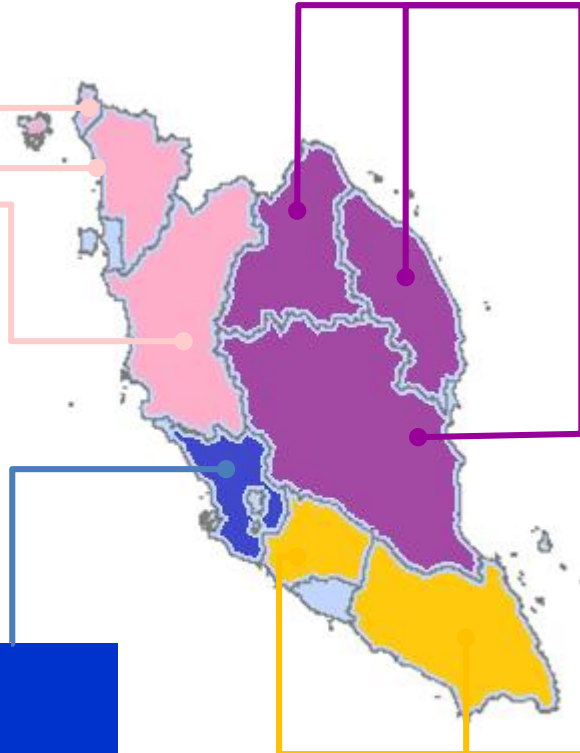

Please refer to Appendix 2, page 27-30 of the RFP

ELIGIBILITY CRITERIA (1/2)

1. Holder of valid licences issued under the CMA:
 - i. Network Facilities Provider (Individual), “NFP(I)”
 - ii. Network Service Provider (Individual), “NSP(I)”
 - iii. Applications Service Provider (Class), “ASP(C)”

2. The NFP(I) licence held by the Licensee must allow the holder of the licence to own or provide ALL of the following network facilities:
 - i. Fixed links and cables;
 - ii. Towers, poles, ducts and pits used in conjunction with other network facilities; and
 - iii. There shall be no last mile limitation specified in the NFP(I) Licence.



Please refer to subparagraph 4.1, page 15-16 of the RFP

ELIGIBILITY CRITERIA (2/2)

3. The Licensee shall also meet the following requirements:
 - i. Has existing fibre optic broadband access network and service with active retail customers;
 - ii. Be able to show good track record of commercial deployment as a licensee under the CMA;
 - iii. Must have satisfactory track record of compliance under the CMA and conduct as a licensee;
 - iv. Not owe any outstanding fees (licence, spectrum assignment and/or numbering assignment) to the Commission;
 - v. Has duly submitted its Return of Net Revenue (RONR) forms to the Commission for each year without fail;
 - vi. Has no outstanding USP Fund contribution; and
 - vii. Has no outstanding compound to the Commission.



Please refer to subparagraph 4.1, page 15-16 of the RFP

KEY REQUIREMENTS UNDER NFCP 3 PROJECT

To improve the efficiency of the investment made via the USP Fund and ensure effective roll out

No	Requirements	Subparagraph(s) in the RFP which can be referred to
1	Customised Bill of Quantity (BOQ)	Interpretation (c), Page 5
2	Self-declaration for completion of work and claim(s) process <ul style="list-style-type: none"> • Dispensing with report to facilitate faster project turnaround time and claim(s) processing • Template for declaration will be in the form and format specified by the Commission to the Designated Universal Service Provider(s) (DUSP), in the Notification of Approval • Declaration shall be made by CEO (or any person who holds an equivalent designation) and external licenced auditor appointed by the DUSP 	<ul style="list-style-type: none"> • Interpretation (h), Page 5 • Appendix 9, Page 41
3	Matching investment approach	Subparagraph 3.30 – 3.34, Page 14

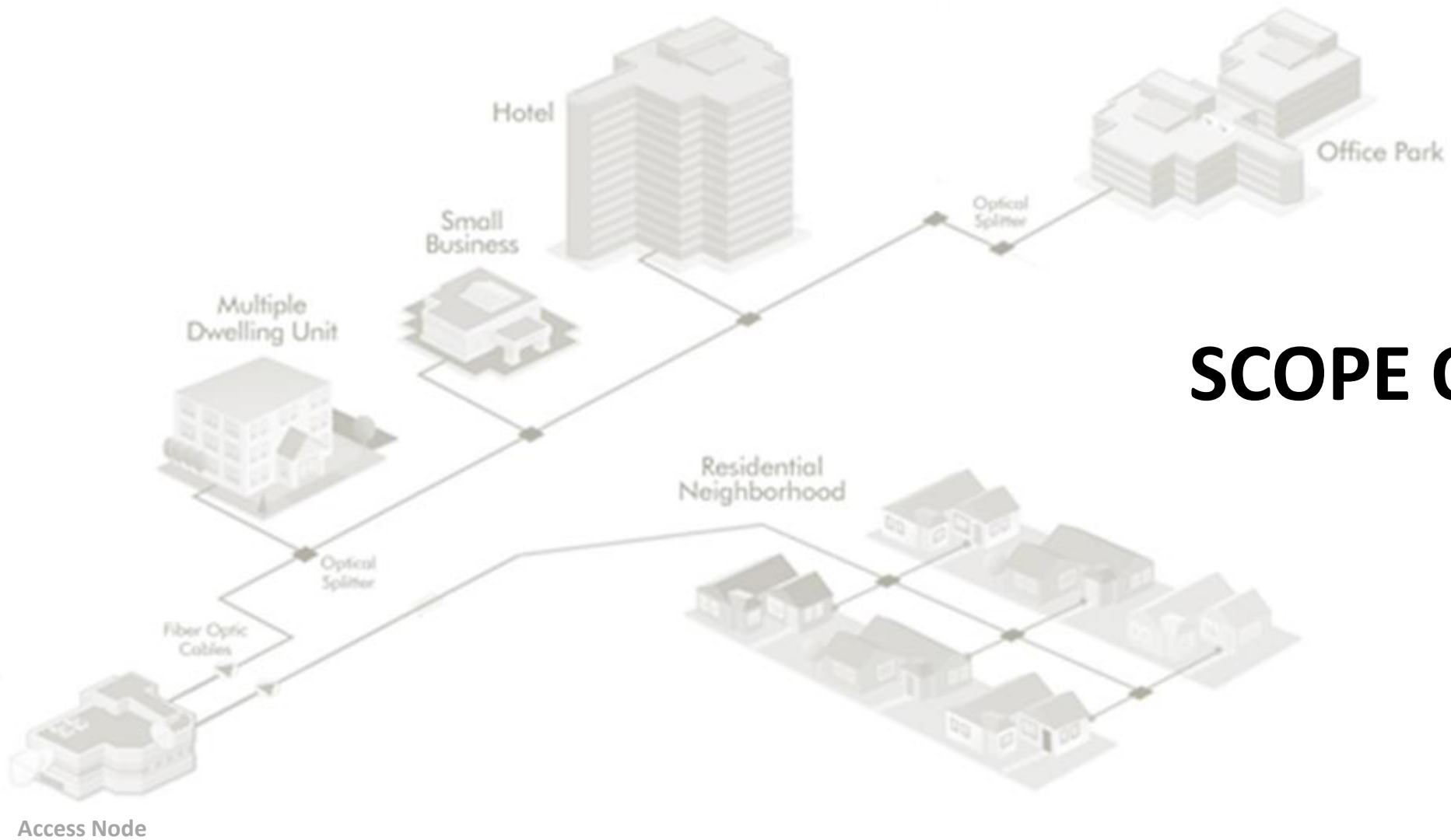

SCOPE OF WORK

MAIN SCOPE OF WORK

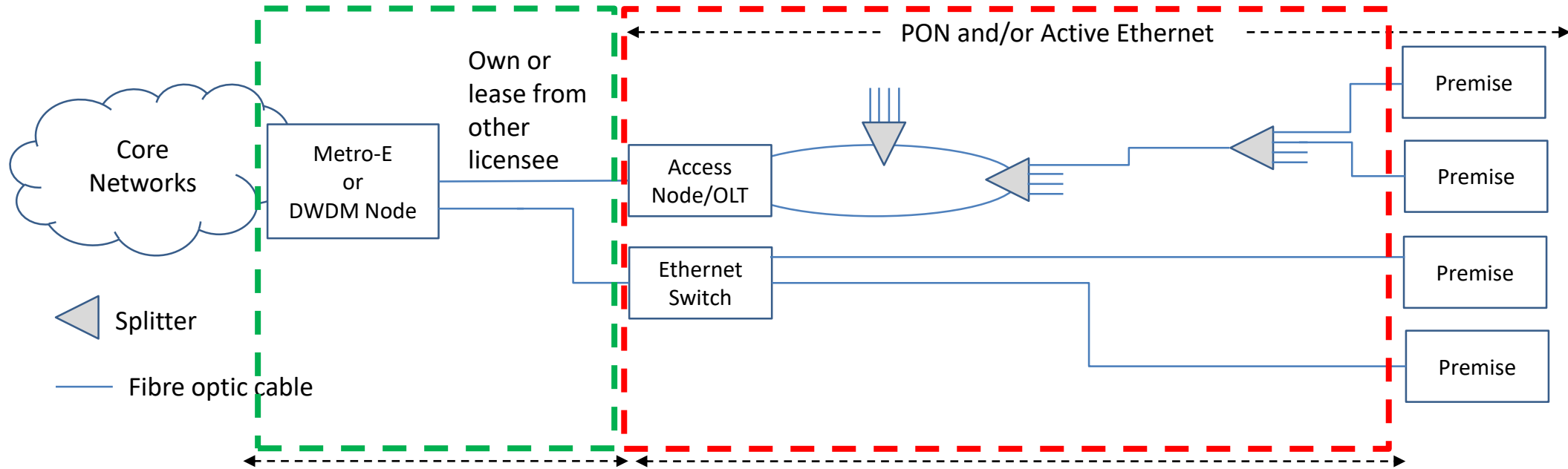

- 3 Design, install, test and commission the trunk network to enable end to end service delivery
- 2 Design, supply, install, test and commission the fibre optic broadband access network
- 6 Provide retail broadband access services
- 4 Operate, maintain and manage the network at own cost
- 5 Provide an open access platform to enable access seeker to participate in the network

- 1 Identify and propose sites (e.g. Taman, Kampung, buildings, business parks, etc) within the target location
*Each target location may consist of multiple sites

SITE SELECTION CRITERIA AND REQUIREMENTS

- 1 Sites to be covered shall be within Universal Service Target areas
- 2 No existing fibre optic access network and FTTH service available
- 3 No copper broadband services available
- 4 A premise is considered covered or passed when all of the following conditions are met:
 - i. Capable to connect the premise to the FTTP network in a service area;
 - ii. New service activation will only require the installation and/or connection of a drop cable from the premises passed point (e.g. fibre distribution point (aerial), fibre distribution point (pedestal), riser, MDF, utility-pole) to the premises, and the installation of customer premises equipment (CPE) at the premises; and
 - iii. New service activation for any access seeker and to any potential users shall be completed within fourteen (14) days.



EXAMPLE OF POTENTIAL SITES IN TARGET LOCATIONS

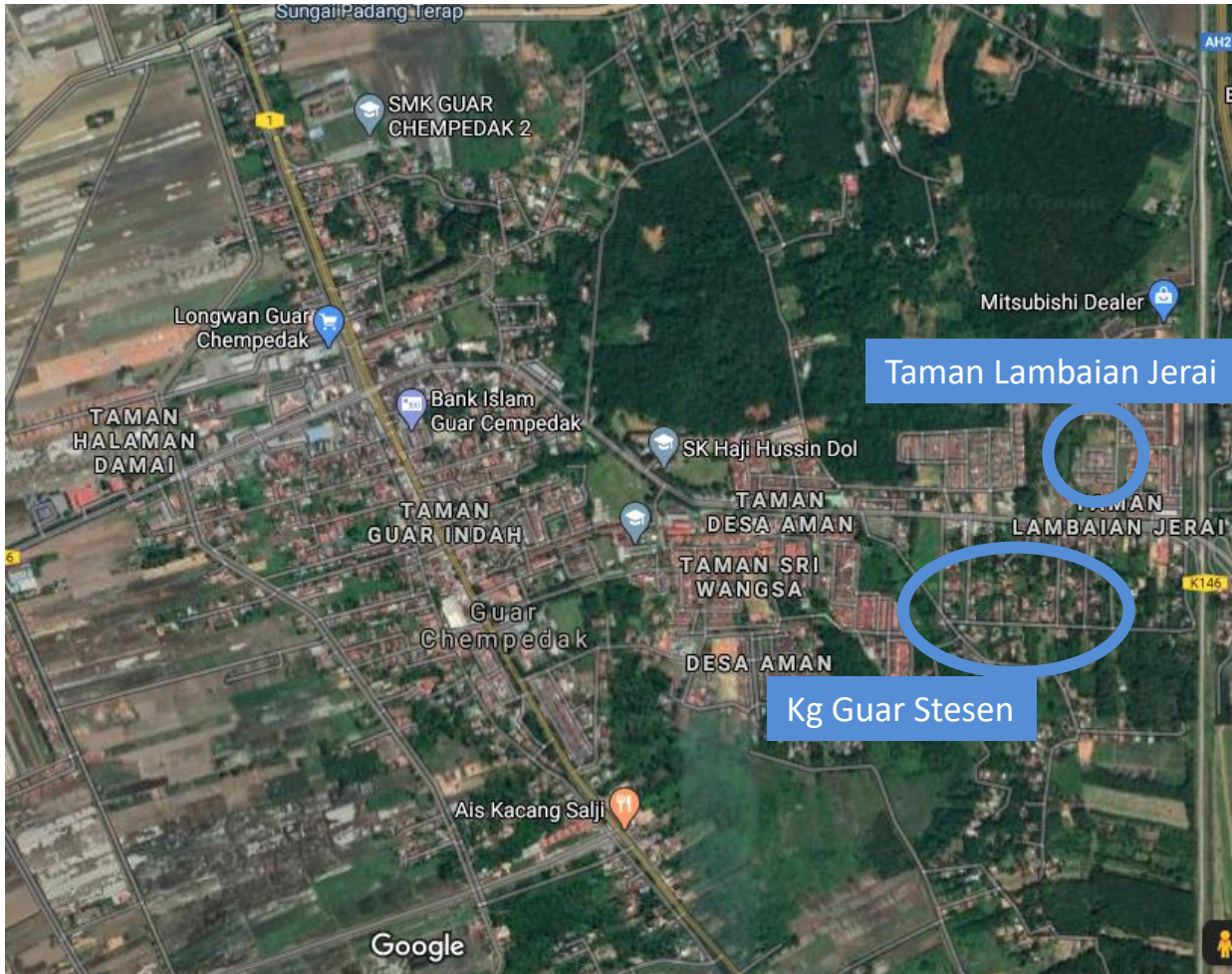

Target location: Guar Chempedak, Kedah

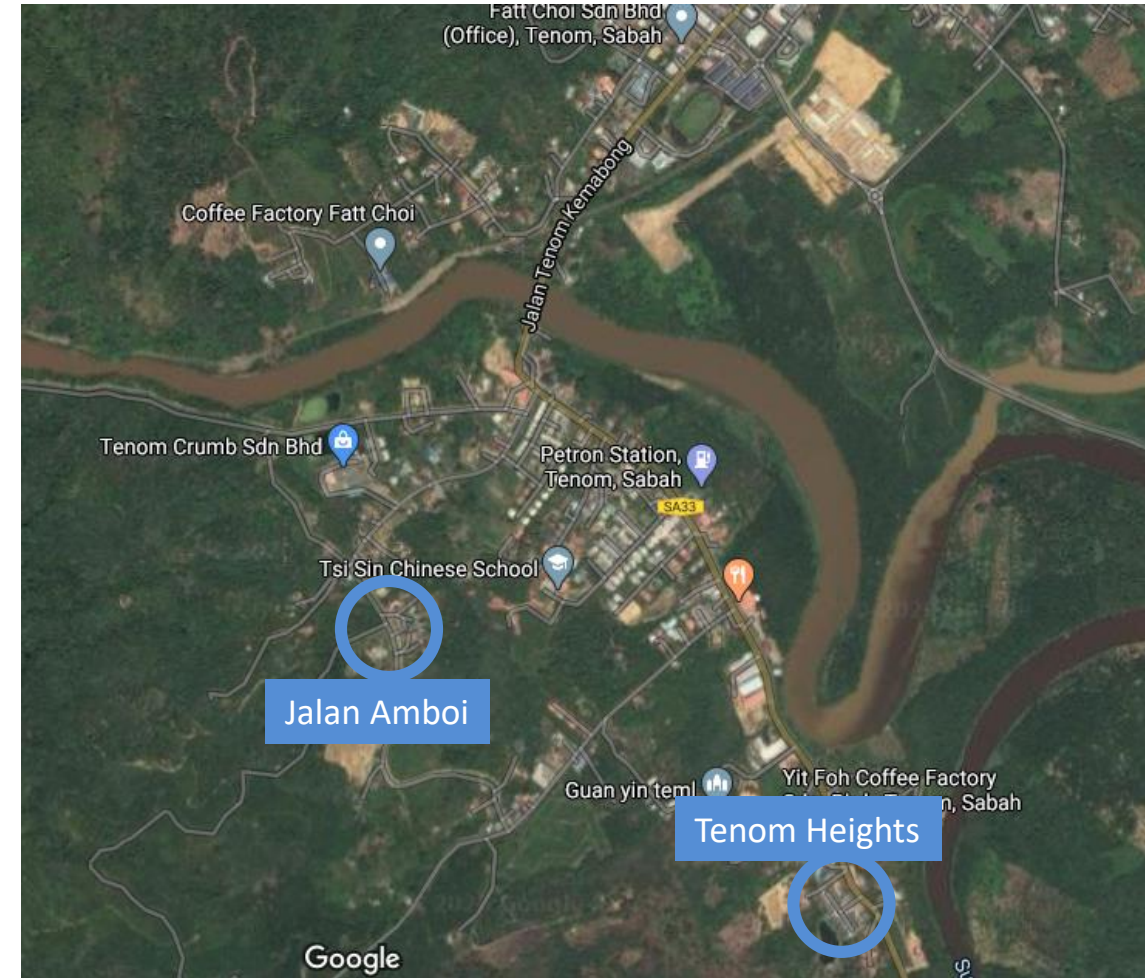

Target location: Tenom, Sabah

 Possible site

OTHER KEY SCOPE OF WORK

The Designated Universal Service Provider shall be responsible for the following:

1. Obtain all the necessary approvals from all relevant authorities;
2. Provide detailed milestone of key activities for project tracking and monitoring purposes;
3. Submit progress report on a fortnightly basis and declaration upon completion of work; and
4. Prepare, compile and maintain the completion report for submission to the Commission upon request.

TECHNICAL REQUIREMENTS



1

Passive Optical Network (PON) and/or Active Ethernet Technology

2

Design must be cost effective, improve the efficiency of the investments made via the USP Fund

3

Network dimensioning to take consideration the population density, network capacity and coverage requirements

4

Open access platform (layer 2 and layer 3 network connection) for interconnection with other service providers

5

Install minimum 48 core fibre optic cable and enable access to dark fibre (minimum 10 fibre pairs) on new trunk network



Please refer to subparagraph 3.1 to 3.6, page 9-10 of the RFP

SERVICE REQUIREMENTS



The designated universal service provider shall:

- provide broadband access retail service with **speeds of at least 30Mbps** and **up to 500Mbps** or higher for user(s) in the target locations
- provide list of initial **retail broadband packages** to be offered to the subscribers
- provide **infrastructure sharing** for the relevant components of the network to minimise duplication of infrastructure
- provide **reasonable charges** for access
- provide **wholesale services charges** on the relevant components of the network to be imposed on access seekers

USP FUNDING

- The funding for NFCP 3 shall be solely for **capital costs**.
- The interested licensee shall include in the Draft Universal Service Plan the bill of quantity and all appropriate information including the capital expenditure costs relating to the design, supply, delivery, installation, testing and commissioning of this project.

MATCHING INVESTMENT APPROACH

- NFCP 3 requires “**matching investment approach**” of proposed project value
- Interested licensees are required to propose self-funded initiatives to deploy fibre optic networks

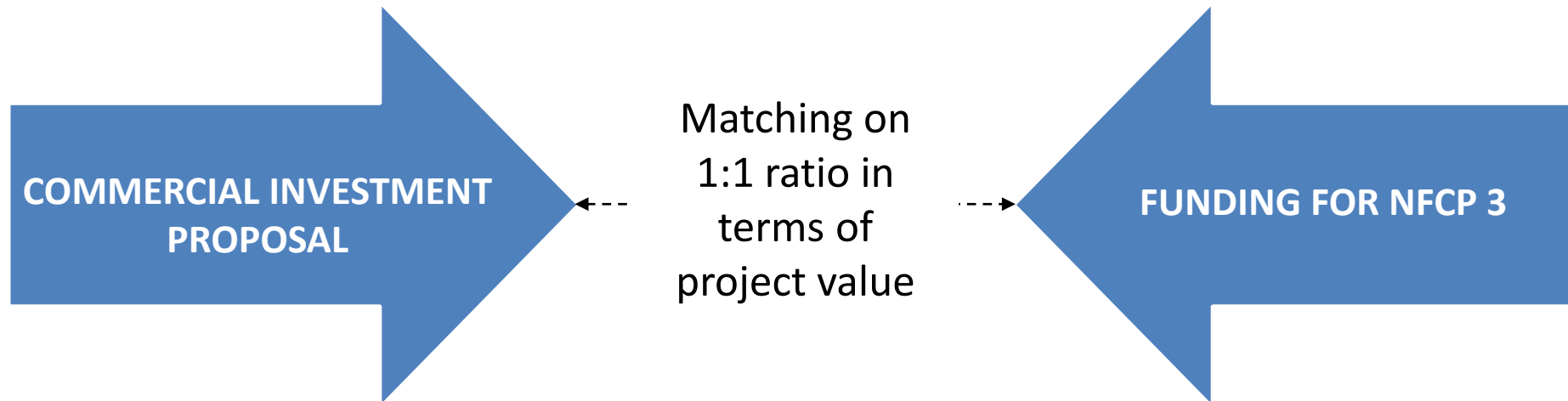

- Submit written commercial deployment plan to match the value proposed under the USP Fund for the NFCP 3 project

GUIDE ON MATCHING INVESTMENT



1

Scope

Shall contribute to NFCP targets.

Examples:

- Gigabit network
- Fibre access network
- Fiberising towers

2

Implementation Period

From date of draft plan submission onwards (12 May 2020)

3

Location

Unrestricted, but encouraged for areas within the vicinity of the target locations that it is bidding

4

Restriction

Not initiatives funded by Government / USP

KEY POINTS DURING IMPLEMENTATION

1 Performance Bond 10% of total approved cost

- 2 Advance Payment (10%)**
1. Acceptance of Notification of Approval
 2. Acceptance of Performance Bond

- 3 Capital Expenditure (90%)**
1. Submission of declaration by the DUSP and external auditor on the completion of works at particular cluster
 2. Submission of fibre networks into database managed by the Commission
 3. Submission of declaration by the DUSP and external auditor on the completion of commercial roll out

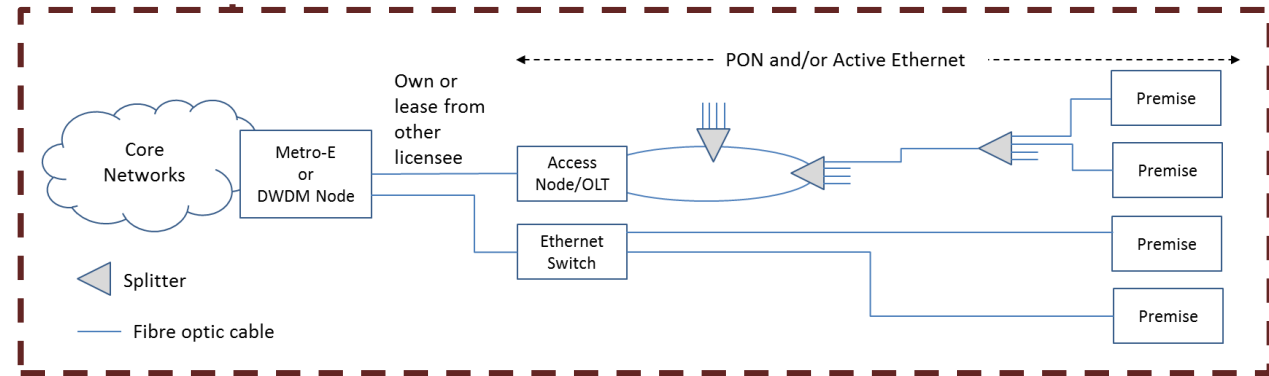

Implementation Period 18 months; Report(s) on a fortnightly basis

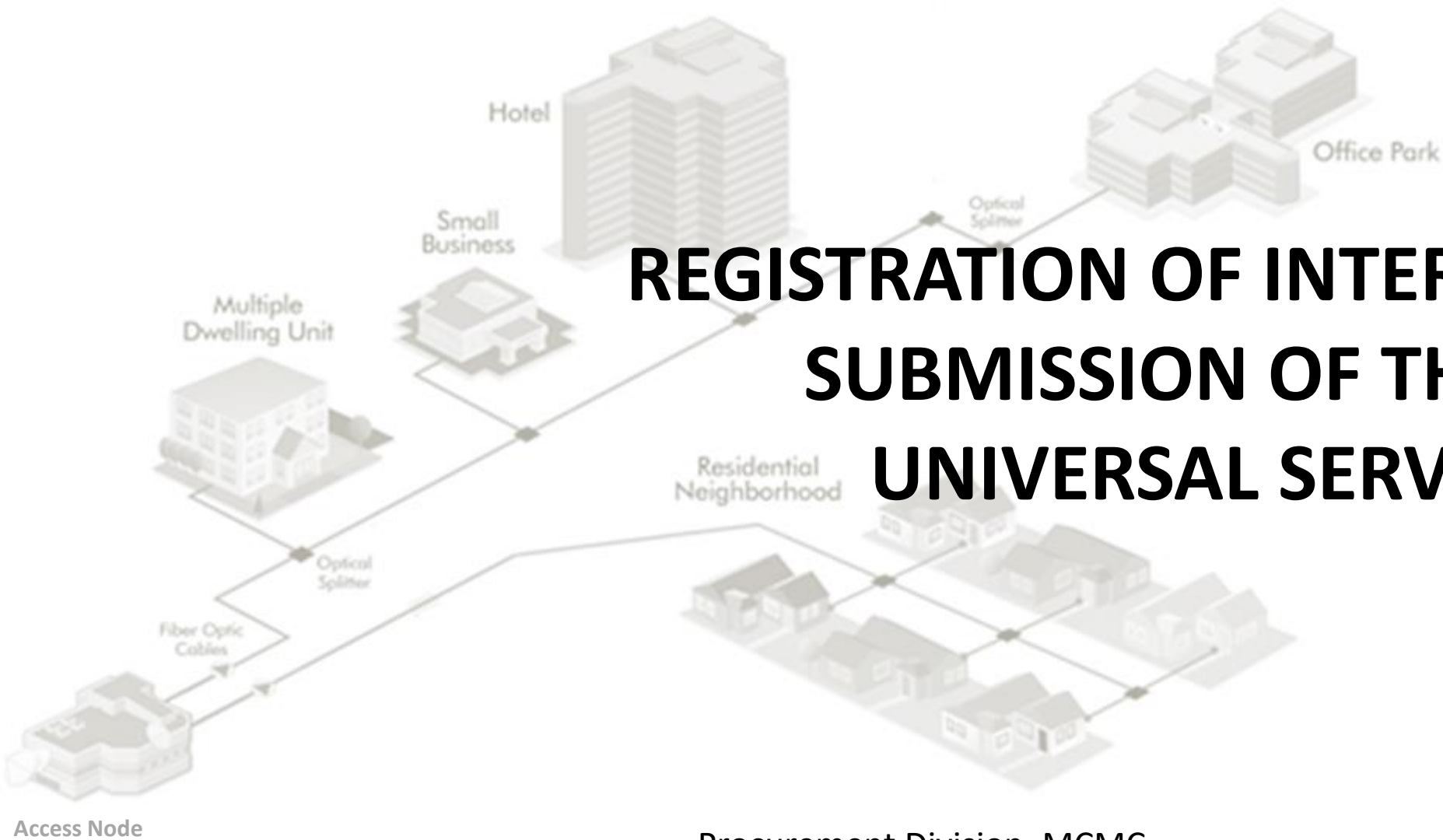

REGISTRATION OF INTEREST AND SUBMISSION OF THE DRAFT UNIVERSAL SERVICE PLAN

Procurement Division, MCMC
21st February 2020

NFCP3 RFP Timeline

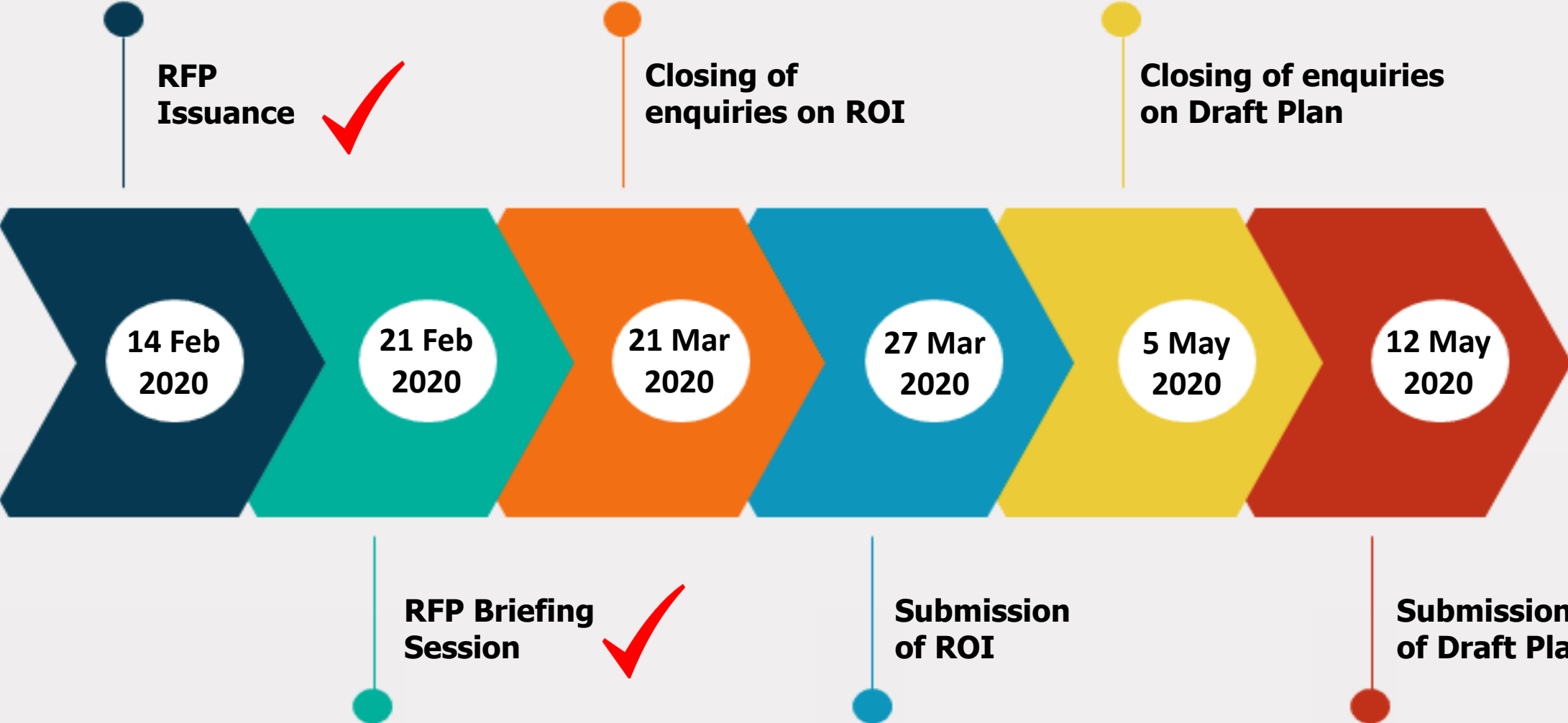



Closing Date: **TENDER CLARIFICATION**



Strictly via email to tender@mcmc.gov.my

1 ROI

 Before 5:00pm

 On **21 March 2020**

2 DRAFT UNIVERSAL SERVICE PLAN

 Before 5:00pm

 On **5 May 2020**

Feb 2020

March 2020

April 2020

May 2020

Enquiries will be uploaded in MCMC Website.

<https://www.mcmc.gov.my/>

Closing Date: **SUBMISSIONS**



To complete **acknowledgement form**
at the counter provided.

1 ROI

 From **9:00am to 12:00pm**

 On **27 March 2020**

 At **MCMC Old Building,**
Cyberjaya

2 DRAFT UNIVERSAL SERVICE PLAN

 On or Before **12:00pm**

 On **12 May 2020**

 At **MCMC Old Building,**
Cyberjaya

March 2020

April 2020

May 2020

REQUIREMENT FOR DRAFT UNIVERSAL SERVICE PLAN SUBMISSION



Licensee's Information



1

✓ 1 Original

✓ 1 Digital Copy
(CD or Thumb drive)

Technical Submission



2

✓ 1 Original & 2 Copy

✓ 1 Digital Copy in PDF format (CD or Thumb drive)

Financial Submission



3

✓ 1 Original & 2 Copy

✓ 1 Digital Copy in PDF format (CD or Thumb drive)

To be submitted in sealed packages

Important Notes...



All information & updates are at MCMC Website



Draft Plans submission according to ROI



Be aware and comply with of the required signatories



No company name/info in Technical Submission



The MCMC Tender Secretariat will be the only **point of contact** for this project.

tender@mcmc.gov.my



THANK YOU